

P2097SS

Verbindingsstuk geplooid 60° 2D14

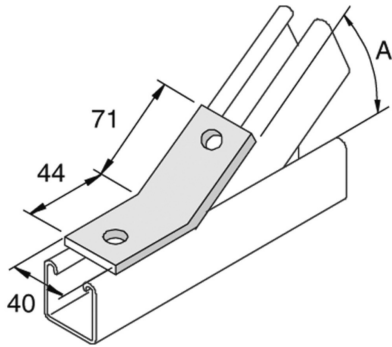

Stand. Uitv.

Inox 316

HD	Artikel	↕ mm	↔ mm	→ ← mm	↔ mm	kg/stk	📦	Stock	Eenh.
-	P2097SS		40			0,194	10		STK