

P2095

Verbindingsstuk geplooid 75° 2D14

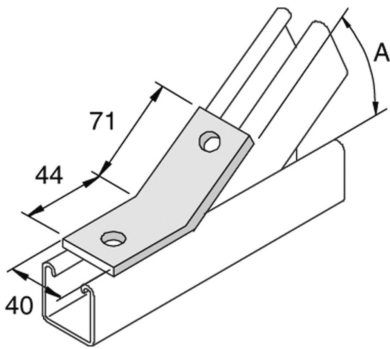

Stand. Uitv.

Hot-Dip

HD	Artikel	↕ mm	↔ mm	→ ← mm	↔ mm	kg/stk	📦	Stock	Eenh.
-	P2095					0,188	10		STK

A = 75°

Afkorting:

- HG = Hot-Dip Gegalvaniseerd